



5X428BR X 425BR

Floor Closer Threshold

PRODUCT CUT SHEET

PROJECT:
SUBMITTED BY:
DATE:
NOTES:

Material

Alloy CDA 385 (Copper Alloy No. C38500)

- 8" Wide at Floor Closer, Balance 5" Wide x 1/2" Tall x 36" Length
- Fluted Top
- Thresholds Can Be Fabricated For Use With Any Floor Closer
- Typical Wall Thickness: .187"
- Weight: 2.84 Lbs./Ft.
- #10 x 1 1/2" Brass Wood Screws Included. Antique Bronze Finish Screws Supplied With DKB Thresholds

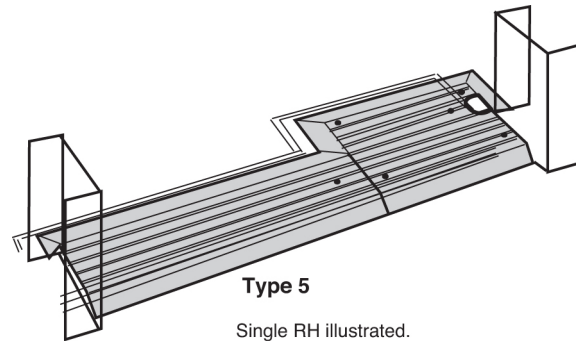

Finish

Architectural Bronze Satin Finish (728) Similar to US4

Optional Finishes:

Polished (721), Suffix "POL"
 Dark Oxidized Oil Rubbed (722)
 Similar to US10B, Suffix "DKB"

Options

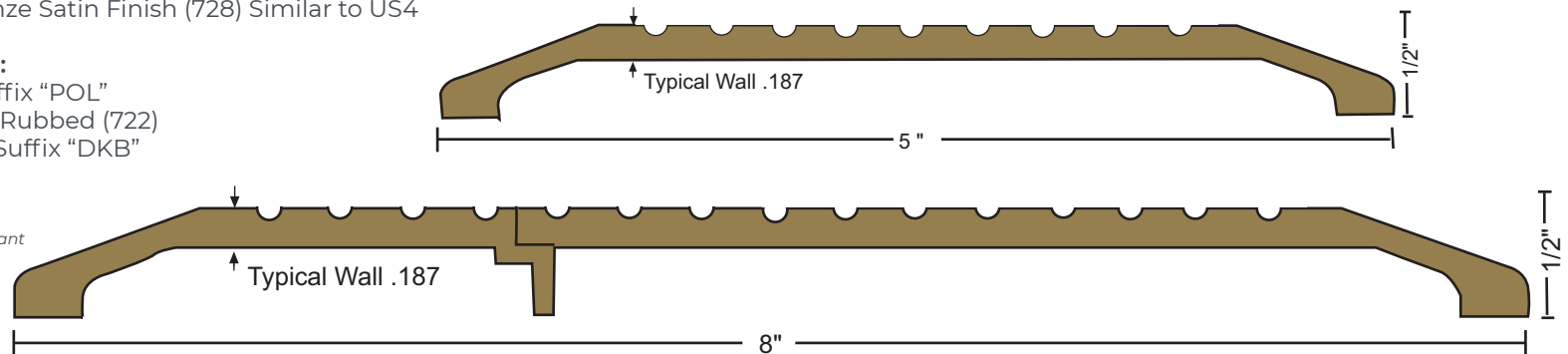

NGP-THR-5X428BR X 425BR-PCS-1023-A

NATIONAL GUARD PRODUCTS, INC.

MEMPHIS

4985 East Raines Road
Memphis, TN 38118

CARSON CITY

3689 Arrowhead Drive
Carson City, NV 89706

Fax: (800) 255-7874

Email: info@ngp.com

Quotes: quotes@ngp.com

Orders: orders@ngp.com

ngp.com
1-800-NGP-RUSH