

VINYL SEALS

All Vinyl Seals this Section:



- ▶ Thermoplastic Polymer: Polyvinyl Chloride Formulated with an Environmentally Friendly Bio-Based Plasticizer
- ▶ Economical
- ▶ Flame-Resistant
- ▶ Moisture-Resistant
- ▶ Temperature Range 0°F to 140°F
- ▶ Oxidative Degradation from Age and Exposure to Cold, Heat and UV Causes Hardening, Loss of Memory and Resilience, Cracking, Cracking and Discoloration
- ▶ #6 x 3/4" Stainless Steel Sheet Metal Screws Furnished
- ▶ Screw Holes Slotted for Adjustment

160VA
Anodized Aluminum
Vinyl Perimeter
Seal

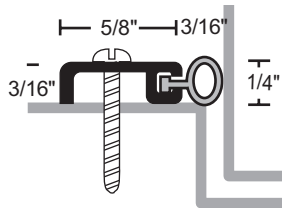
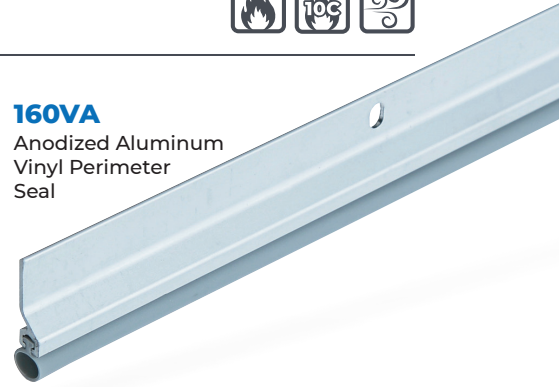

PRODUCT#	INSERT	FINISH
152V	Gray Vinyl	Mill Al
152VA	Gray Vinyl	Anodized Al
152VB	Gray Vinyl	Gold
152VDKB	Black Vinyl	Dark Bronze

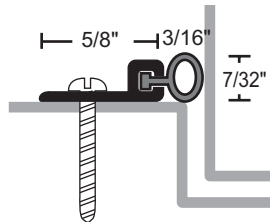

PRODUCT#	INSERT	FINISH
155V	Gray Vinyl	Mill Al
155VB	Gray Vinyl	Gold
155VDKB	Black Vinyl	Dark Bronze

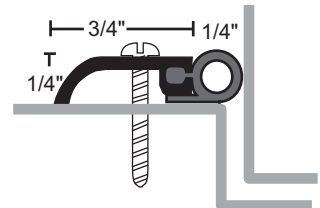

PRODUCT#	INSERT	FINISH
156V	Gray Vinyl	Mill Al
156VDKB	Gray Vinyl	Dark Bronze

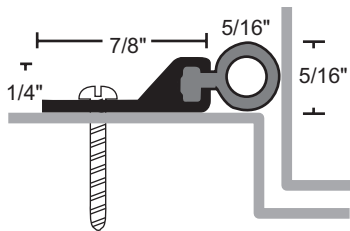

PRODUCT#	INSERT	FINISH
160V	Gray Vinyl	Mill Al
160VA	Gray Vinyl	Anodized Al
160VB	Gray Vinyl	Gold
160VDKB	Black Vinyl	Dark Bronze

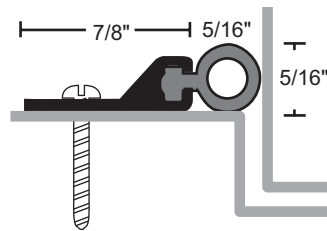

PRODUCT#	INSERT	FINISH
161VA	Gray Vinyl	Anodized Al
161VDKB	Black Vinyl	Dark Bronze

.07 Aluminum for Military Specs

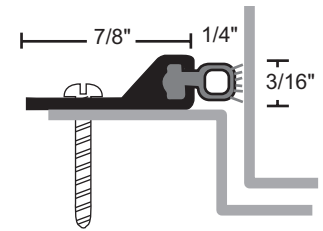

PRODUCT#	INSERT	FINISH
164V	Gray Vinyl	Mill Al
164VA	Gray Vinyl	Anodized Al
164VB	Gray Vinyl	Gold
164VDKB	Gray Vinyl	Dark Bronze

POLYPROPYLENE PILE SEALS

- ▶ Temperature Range 32°F to 275°F
- ▶ Pile is Gray

185P
185PA
185PB
185PDKB

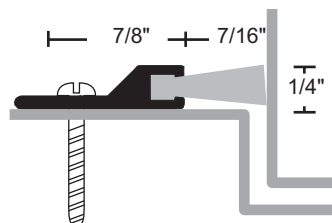

161PA
161PDKB

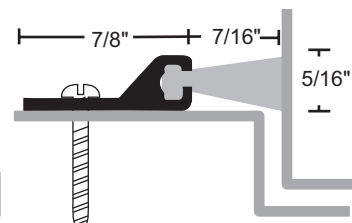

.07 Aluminum for Military Specs